

TRENCH SHIELD TABULATED DATA

5385 Bay Oaks Dr.
Pasadena TX 77505

Model Number:	URS-6M-824SKE	Wall Thickness:	6"	Spread. Pin Diameter:	2"
Serial Number:	U-PS22214-X	Spreader Size:	8" SCH. 80	Pin Yield Strength:	150 KSI
Height:	8'	Spreader Yield :	35 KSI	Pressure Rating:	1,412
Length:	24'	Max Spread. Length:	13'	Manufacture Date:	05/23/2022

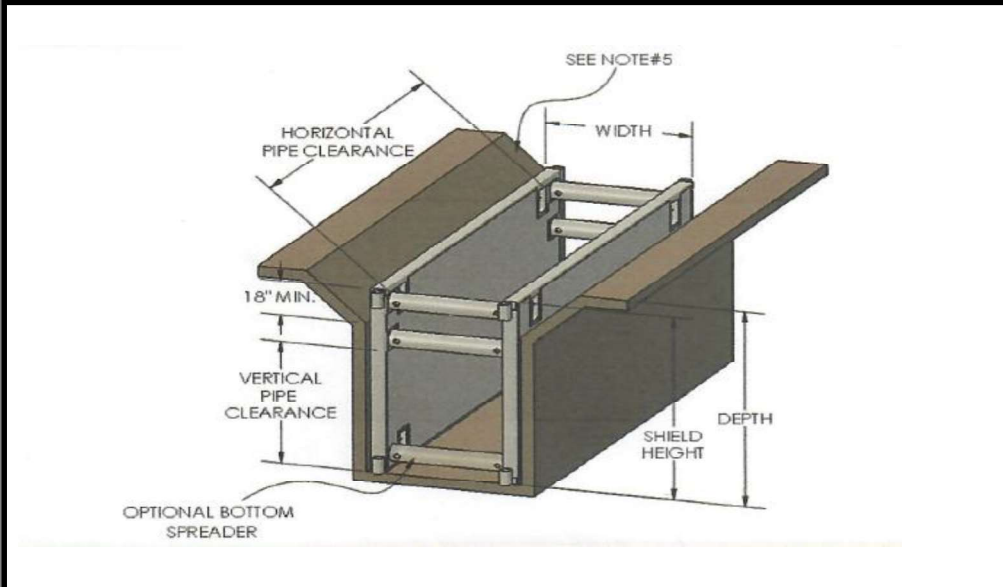

SOIL TYPE	DEPTH RATING
A-25	50'
B-45	35'
C-60	28'
C-80	22'

05/23/2022

NOTES & LIMITATIONS:

- 1) This document has been prepared by a Registered Professional Engineer (P.E.), as required by OSHA standard 29 CFR, Part 1926, Subpart P.
- 2) Shields shall be used under the supervision and direction of a Competent Person, who is educated and trained in the use of shoring shields, and has experience in the field with shield use, OSHA soil type classification, and recognizing hazardous conditions.
- 3) Shields must be used in strict compliance with all applicable OSHA guidelines, and limitations outlined in this document. Failure to do so can result in serious injury or death.
- 4) Shields shall be inspected prior to each use, to ensure they are in good condition and free of any damage or visual defects.
- 5) Soils shall be sloped in accordance with OSHA Subpart P. and must extend to no less than 18" below the top of the shoring shield. Shield does not need to extend above soil when adjacent soils are flat and level with top of shield.
- 6) Soil shall be classified by a Competent Person as type A, B, C, as defined by OSHA regulations.
- 7) Shields may be stacked, if appropriate connections are made between the stacked shields to prevent lateral movement.
- 8) Prior to shield use all spreaders shall be secured to sockets with pins, or other mechanical connections, that are approved by the manufacturer. Do not apply side load to the spreaders at any time (such as leaning plates for soil support), unless approved in writing by P.E.
- 9) Collar adaptors are required to utilize 10" Sch. 80 spreader pipe.
- 10) Shield shall be installed in a manner to restrict lateral or other hazardous movement of the shield in the event of the application of sudden lateral loads.
- 11) Competent person must ensure surcharge limits and equipment setbacks are maintained at all times, unless approved in writing by a P.E.