

ARCH SPREADER TABULATED DATA

5340 Bay Oaks Dr.
Pasadena TX 77505

Model Number:	ARCH-PIPE-120/144	Max. Spreader Length:	15'	SOIL TYPE	DEPTH RATING
Serial Number:	PS23661	Spreader Size:	8" SCH. 80		
Max. Shield Height:	10'	Spreader Yield Strength:	35 KSI	A-25	40'
Max. Shield Length:	24'	Spreader Pin Diameter:	2"	B-45	40'
Max. Height Clearance on 8' Tall Shields:	120"	Pin Yield Strength:	90 KSI	C-60	31'
Max. Height Clearance on 10' Tall Shields:	144"	Manufacture Date:	2/20/2024	C-80	24'

NOTES & LIMITATIONS:

IMPORTANT NOTICE: THIS DEPTH CHART DOES NOT SUPERCEED ORIGINAL MANUFACTURERS'S TABULATION DATA OF SHIELD CAPACITY AND DEPTH RATINGS. THIS ARCH SPREADER SYSTEM CAN BE EQUAL TO OR LESS THAN THE MAXIMUM DEPTH RATING OF THE INTENDED TRENCH SHIELD, BUT MUST NEVER EXCEED THE PARAMETERS LISTED ABOVE.

- 1) This document has been prepared by a Registered Professional Engineer (P.E.), as required by OSHA standard 29 CFR, Part 1926, Subpart P.
- 2) Arch Spreaders shall be used under the supervision and direction of a Competent Person, who is educated and trained in the use of shoring shields, Arch spreaders, and has experience in the field with shield use, OSHA soil type classification, and recognizing hazardous conditions.
- 3) Arch Spreaders and shields must be used in strict compliance with all applicable OSHA guidelines, and limitations outlined in this document.
- 4) Arch Spreaders shall be inspected prior to each use to ensure they are in good condition and free of any damage or visual defects.
- 5) Soils shall be sloped in accordance with OSHA Subpart P. and must extend to no less than 18" below the top of the shoring shield. Shield need not to extend above soil when adjacent soils are flat and level with top of shield.
- 6) Soil shall be classified by a Competent Person as type A, B, C, as defined by OSHA regulations.
- 7) Surcharge loads are not included in the maximum depth table. Surcharge loads are possible due to heavy equipment, vibrations, or soil piles adjacent to the trench. (Adjacent is defined as within a distance equal to the depth of the trench).
- 8) Arch spreaders are not intended to provide stability to adjacent buildings or other structures.
- 9) Arch spreaders shall be secured to the sockets with 2" diameter connecting pins.
Do not apply side loads to the arch spreaders at any time (such as leaning plates for soil support).
- 10) Competent person must ensure surcharge limits and equipment setbacks are maintained at all times, unless approved in writing by a P.E.
- 11) Modifications of any kind to this Arch spreader not specifically allowed by Pacific Shoring Products in writing will void this data.



Signed on 2/20/2024

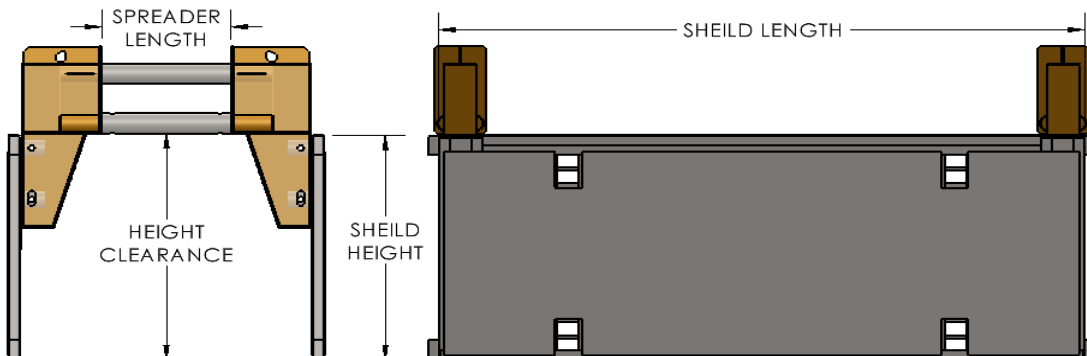
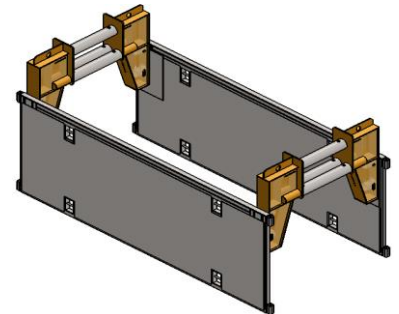

ANY USE OF THIS PRODUCT NOT IN ACCORDANCE WITH THIS TABULATED DATA COULD CAUSE STRUCTURAL FAILURE, COLLAPSE AND LEAD TO SERIOUS INJURY OR DEATH.