

TRENCH SHIELD TABULATED DATA

3810 Magnolia Pkwy
Pearland TX 77584

Model Number: 01.TS-6M1024KE-NTS

Serial Number	PS26865	Spreader Pin Diameter	2 IN	Pressure Rating¹⁹	647 PSF/901 PSF
Trench Shield Height	10 FT	Pin Yield Strength	90 KSI	Weight	16154 LBS
Trench Shield Length	24 FT	Vert Pipe Clearance	84 IN	Surcharge	72 PSF
Wall Thickness	6 IN	Horiz Pipe Clearance	264 IN	33% Shoring Factor	YES

SOIL TYPE	Hs (FT)	MAX SLOPE	MAXIMUM DEPTH (FT)	MAX SPREADER LENGTH (FT) 8" SCHD 80 F _y =35 KSI	MAXIMUM DEPTH (FT)	MAX SPREADER LENGTH (FT) 8" SCHD 80 F _y =65 KSI
A-25	10.5	3/4:1	28	20	38*	20
B-45	8.5	1:1	18	20	23*	20
C-60	6.5	1 1/2:1	15	20	19*	20
C-80	0	Flat	12	20	16*	20

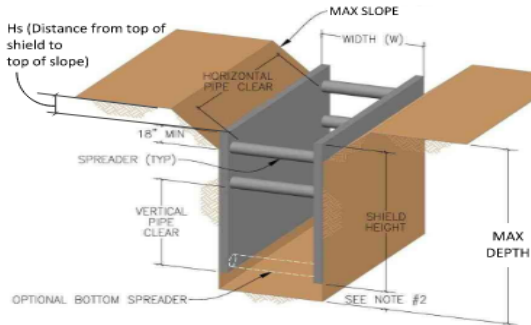

NOTES & LIMITATIONS:

- 1) The exterior wall of the trench shield shall be in direct contact with soils.
- 2) Excavation 2' below bottom of shield is only permitted when there is no indication of possible loss of soil from behind or below the bottom of the shield.
- 3) Sloped soils must extend to no less than 18" below the top of the shield, as shown in diagram above. Shield need not extend above soil when soils are flat and level with top of shield.
- 4) Except as approved in table above (Hs), any excavations over 20'-deep with sloping require site specific approval by a Licensed Professional Engineer (P.E.).
- 5) If "Maximum Depth" exceeds 20', slope angle shall not exceed "Max Slope", and distance from top of shield to top of slope shall not exceed "Hs", as outlined in table for corresponding soil types.
- 6) The "Maximum Depth", regardless of slope, is the vertical distance from the dredge line to original grade and includes Hs and any shield extension above vertical cut.
- 7) User is responsible for safe support of shield to ensure it cannot shift vertically or horizontally at any time.
- 8) Shield may be stacked, provided that appropriate connections are made between the stacked shields to prevent lateral movement.
- 9) Shield must be used in strict compliance with all applicable OSHA guidelines and limitations outlined in this document.
- 10) This document has been prepared by a P.E., as required by OSHA 29 CRF, Part 1926, Subpart P.
- 11) Shield shall be used under the supervision and direction of a Competent Person as defined by CRF, Part 1926, Subpart P. Among other qualifications, the Competent Person shall be trained in the use of trench shields and have practical field experience with the use of shields, soil classification, and recognizing hazardous conditions.
- 12) All spreaders shall be secured to sockets with pins or other mechanical connections approved by the manufacturer, prior to shield use. Do not apply side load or vertical load to the spreaders at any time (such as leaning plates/sheeting for soil support), unless approved in writing by a P.E. or the Manufacturer.
- 13) Shield shall be installed in a manner to restrict lateral or other hazardous movement of the shield in the event of the application of sudden lateral loads.
- 14) Shield shall be inspected prior to each use, to ensure they are in good condition and free of any damage or visual defects.
- 15) Any repairs or modifications to the shield, such as extending height or length with plates, are strictly prohibited, unless approved in writing by a P.E.
- 16) Pressure rating is a triangular pressure distribution based on C-60 soil at bottom of the excavation.
- 17) User must ensure that the groundwater level on all sides of the shoring is maintained below the base of the excavation at all times, otherwise, this certification is invalid.
- 18) All equipment and materials shall be kept a sufficient distance clear of the shoring, as directed by a licensed Professional Engineer, to ensure this surcharge limit is not exceeded.
- 19) Larger PSF strictly applies to condition where depth is controlled by spreader compression and/or bearing capacity. See corresponding tab data.

***To achieve tabulated depth ratings, the Owner shall use 8 in. NPS Schedule 80 pipe spreaders with minimum specified yield strength F_y ≥ 65 ksi (API 5L X65 or approved equal) and provide certified MTRs, calculations, and/or load testing if requested for P.E. approval.**

WARNING: USE OF SHIELDING OTHER THAN OUTLINED IN THIS DOCUMENT CAN CAUSE FAILURE, COLLAPSE, OR CAVE-INS, AND MAY RESULT IN SERIOUS INJURY OR DEATH.